

COMPONENTI IDROTERMOSANITARI

COMISA®

egeda



KATALOG - CATALOGUE

15/10/2022





COMISA®

COMPONENTI IDRO TERMO SANITARI

QUALITÄT eine ENTSCHEIDUNG FÜRS LEBEN • **QUALITY** a CHOICE OF LIFE



COMISA

ÜBER **40 Jahre** - ERFAHRUNG und **QUALITÄT**

MORE THAN **40 years** OF EXPERIENCE and **QUALITY**



- **PRESSSYSTEM UND KLEMMVERBINDER FÜR METALLVERBUNDROHR**
METALLVERBUNDROHR
VERTEILER
VENTILE UND VERSCHRAUBUNGEN
FUSSBODENHEIZUNG
SONNENENERGIE

- **PRESS FITTINGS AND SCREW FITTINGS FOR MULTILAYER PIPE**
MULTILAYER PIPE
MANIFOLDS
VALVES AND SCREW FITTINGS
UNDERFLOOR HEATING
SOLAR ENERGY

COMISA[®]

PRESS

PRESSYSTEM FÜR METALLVERBUNDRÖHR
PRESS FITTINGS FOR MULTILAYER PIPE

MESSING - BRASS UNI EN 12164/12165 - CW 617N





DW-8501BO0049





KUPPLUNG
COUPLING DOUBLE



ART. NUMMER ARTICLE NUMBER	ABMESSUNG SIZE			EURO
87.10.140	14 x 2	10	100	6,16
87.10.160	16 x 2	10	100	5,43
87.10.161	16 x 2,25	10	100	7,22
87.10.170	17 x 2	10	100	8,02
87.10.180	18 x 2	10	100	6,72
87.10.200	20 x 2	10	80	6,83
87.10.201	20 x 2,5	10	80	7,96
87.10.250	25 x 2,5	5	50	11,15
87.10.260	26 x 3	5	50	10,20
87.10.320	32 x 3	1	30	15,55
87.10.400	40 x 3,5	1	20	28,25
87.10.500	50 x 4	1	10	55,69
87.10.631	63 x 6	1	5	123,52



ÜBERGANG MIT AG
MALE COUPLING



ART. NUMMER ARTICLE NUMBER	ABMESSUNG SIZE			EURO
87.12.140	14 x 2 - 1/2"	10	120	5,60
87.12.160	16 x 2 - 1/2"	10	120	3,54
87.12.161	16 x 2,25 - 1/2"	10	120	4,58
87.12.164	16 x 2 - 3/4"	10	120	6,90
87.12.180	18 x 2 - 1/2"	10	120	4,75
87.12.181	18 x 2 - 3/4"	10	120	7,47
87.12.200	20 x 2 - 1/2"	10	120	4,43
87.12.201	20 x 2 - 3/4"	10	100	6,19
87.12.202	20 x 2,5 - 1/2"	10	120	6,73
87.12.203	20 x 2,5 - 3/4"	10	100	7,47
87.12.250	25 x 2,5 - 3/4"	5	60	12,17
87.12.251	25 x 2,5 - 1"	5	50	12,26
87.12.255	26 x 3 - 1/2"	5	60	11,62
87.12.260	26 x 3 - 3/4"	5	60	8,84
87.12.261	26 x 3 - 1"	5	50	11,35
87.12.320	32 x 3 - 1"	1	40	12,55
87.12.321	32 x 3 - 1 1/4"	1	30	17,80
87.12.400	40 x 3,5 - 1"	1	20	24,58
87.12.401	40 x 3,5 - 1 1/4"	1	20	23,00
87.12.500	50 x 4 - 1 1/4"	1	10	48,67
87.12.501	50 x 4 - 1 1/2"	1	10	37,13
87.12.631	63 x 6 - 2"	1	5	129,27



REDUKTION
REDUCING COUPLING DOUBLE



ART. NUMMER ARTICLE NUMBER	ABMESSUNG SIZE			EURO
87.11.160	16 x 2 - 14 x 2	10	100	6,38
87.11.181	18 x 2 - 16 x 2	10	100	7,01
87.11.200	20 x 2 - 14 x 2	10	100	7,45
87.11.201	20 x 2 - 16 x 2	10	80	7,11
87.11.203	20 x 2 - 18 x 2	10	80	7,45
87.11.205	20 x 2,5 - 16 x 2	10	80	7,28
87.11.206	20 x 2,5 - 16 x 2,25	10	80	9,78
87.11.250	25 x 2,5 - 16 x 2	5	50	10,87
87.11.251	25 x 2,5 - 18 x 2	5	50	11,04
87.11.252	25 x 2,5 - 20 x 2	5	50	11,04
87.11.260	26 x 3 - 16 x 2	5	50	9,55
87.11.262	26 x 3 - 18 x 2	5	50	10,87
87.11.263	26 x 3 - 20 x 2	5	50	9,74
87.11.264	26 x 3 - 20 x 2,5	5	50	9,74
87.11.320	32 x 3 - 16 x 2	1	50	14,05
87.11.321	32 x 3 - 18 x 2	1	50	14,18
87.11.322	32 x 3 - 20 x 2	1	50	14,25
87.11.324	32 x 3 - 25 x 2,5	1	50	14,98
87.11.325	32 x 3 - 26 x 3	1	30	14,25
87.11.400	40 x 3,5 - 25 x 2,5	1	20	26,97
87.11.401	40 x 3,5 - 26 x 3	1	30	26,24
87.11.402	40 x 3,5 - 32 x 3	1	30	26,95
87.11.501	50 x 4 - 32 x 3	1	10	44,00
87.11.600	50 x 4 - 40 x 3,5	1	10	44,74
87.11.640	63 x 6 - 40 x 3,5	1	10	133,12
87.11.650	63 x 6 - 50 x 4	1	10	143,52

ÜBERGANG MIT IG
FEMALE COUPLING



ART. NUMMER ARTICLE NUMBER	ABMESSUNG SIZE			EURO
87.13.140	14 x 2 - 1/2"	10	120	5,44
87.13.160	16 x 2 - 1/2"	10	120	4,43
87.13.161	16 x 2,25 - 1/2"	10	120	9,35
87.13.164	16 x 2 - 3/4"	10	100	8,14
87.13.180	18 x 2 - 1/2"	10	120	6,00
87.13.181	18 x 2 - 3/4"	10	100	7,38
87.13.200	20 x 2 - 1/2"	10	120	5,53
87.13.201	20 x 2 - 3/4"	10	80	7,31
87.13.202	20 x 2,5 - 1/2"	10	120	6,81
87.13.203	20 x 2,5 - 3/4"	10	100	8,42
87.13.250	25 x 2,5 - 3/4"	10	60	10,90
87.13.251	25 x 2,5 - 1"	5	50	12,50
87.13.255	26 x 3 - 1/2"	5	60	10,21
87.13.260	26 x 3 - 3/4"	5	60	9,73
87.13.261	26 x 3 - 1"	5	50	12,45
87.13.320	32 x 3 - 1"	1	40	13,85
87.13.321	32 x 3 - 1 1/4"	1	30	28,05
87.13.400	40 x 3,5 - 1"	1	20	26,20
87.13.401	40 x 3,5 - 1 1/4"	1	20	35,55
87.13.405	40 x 3,5 - 1 1/2"	1	20	35,55
87.13.500	50 x 4 - 1 1/4"	1	10	43,06
87.13.501	50 x 4 - 1 1/2"	1	10	50,56
87.13.631	63 x 6 - 2"	1	5	124,12

SONDERABMESSUNGEN - SPECIAL SIZES



WINKEL 90°
ELBOW 90°



ART. NUMMER ARTICLE NUMBER	ABMESSUNG SIZE	📦	📦	EURO
87.14.160	16 x 2	10	100	6,72
87.14.161	16 x 2,25	10	80	8,02
87.14.180	18 x 2	10	80	9,34
87.14.200	20 x 2	10	60	7,96
87.14.201	20 x 2,5	10	60	9,61
87.14.250	25 x 2,5	5	40	13,62
87.14.260	26 x 3	5	40	12,15
87.14.320	32 x 3	1	20	16,45
87.14.340	40 x 3,5	1	15	30,05
87.14.350	50 x 4	1	10	48,62
87.14.631	63 x 6	1	5	184,10

ÜBERGANGSWINKEL
MIT IG 90°
FEMALE ELBOW 90°

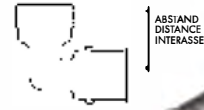

ART. NUMMER ARTICLE NUMBER	ABMESSUNG SIZE	ABSTAND DISTANCE	📦	📦	EURO
87.17.140	14 x 2 - 1/2"		10	80	8,18
87.17.159	16 x 2 - 1/2"	33 mm	10	80	8,25
87.17.160	16 x 2 - 1/2"	25 mm	10	80	5,65
87.17.161	16 x 2,25 - 1/2"		10	80	7,63
87.17.164	16 x 2 - 3/4"		10	80	9,73
87.17.180	18 x 2 - 1/2"		10	80	8,25
87.17.181	18 x 2 - 3/4"		10	60	11,04
87.17.200	20 x 2 - 1/2"		10	60	7,59
87.17.201	20 x 2 - 3/4"		10	50	10,25
87.17.202	20 x 2,5 - 1/2"		10	60	9,55
87.17.203	20 x 2,5 - 3/4"		10	50	11,22
87.17.250	25 x 2,5 - 3/4"		5	40	12,37
87.17.260	26 x 3 - 3/4"		5	40	11,75
87.17.265	26 x 3 - 1"		5	40	14,65
87.17.320	32 x 3 - 1"		1	20	14,90
87.17.400	40 x 3,5 - 1 1/4"		1	15	30,32
87.17.500	50 x 4 - 1 1/4"		1	10	50,55
87.17.501	50 x 4 - 1 1/2"		1	10	52,43

ÜBERGANGSWINKEL MIT AG 90°
MALE ELBOW 90°



ART. NUMMER ARTICLE NUMBER	ABMESSUNG SIZE	📦	📦	EURO
87.16.140	14 x 2 - 1/2"	10	80	7,68
87.16.160	16 x 2 - 1/2"	10	80	7,07
87.16.161	16 x 2,25 - 1/2"	10	80	8,73
87.16.164	16 x 2 - 3/4"	10	80	8,84
87.16.180	18 x 2 - 1/2"	10	80	7,68
87.16.200	20 x 2 - 1/2"	10	80	7,96
87.16.201	20 x 2 - 3/4"	10	60	8,31
87.16.202	20 x 2,5 - 1/2"	10	80	9,54
87.16.203	20 x 2,5 - 3/4"	10	60	10,18
87.16.250	25 x 2,5 - 3/4"	5	40	11,96
87.16.260	26 x 3 - 3/4"	5	40	11,15
87.16.265	26 x 3 - 1"	5	40	14,00
87.16.320	32 x 3 - 1"	1	20	14,60
87.16.400	40 x 3,5 - 1 1/4"	1	15	30,32
87.16.500	50 x 4 - 1 1/4"	1	10	48,67
87.16.501	50 x 4 - 1 1/2"	1	10	50,54

T-STÜCK
TEE

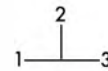

ART. NUMMER ARTICLE NUMBER	ABMESSUNG SIZE	📦	📦	EURO
87.18.140	14 x 2	10	50	10,61
87.18.160	16 x 2	10	50	8,84
87.18.161	16 x 2,25	10	50	9,79
87.18.180	18 x 2	10	40	12,31
87.18.200	20 x 2	10	40	11,25
87.18.201	20 x 2,5	10	40	12,70
87.18.250	25 x 2,5	5	20	19,41
87.18.260	26 x 3	5	20	17,40
87.18.320	32 x 3	1	15	26,20
87.18.400	40 x 3,5	1	10	49,50
87.18.500	50 x 4	1	5	72,50
87.18.631	63 x 6	1	5	235,04

SONDERABMESSUNGEN - SPECIAL SIZES

T- STÜCK MITTELABGANG
REDUZIERT

TEE REDUCED
MIDDLE SECTION

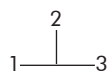

ART. NUMMER
ARTICLE NUMBER

ABMESSUNG
SIZE

10 50

EURO

87.19.181	18 x 2 - 16 x 2 - 18 x 2	10	50	13,26
87.19.201	20 x 2 - 16 x 2 - 20 x 2	10	50	11,65
87.19.202	20 x 2 - 18 x 2 - 20 x 2	10	50	13,26
87.19.204	20 x 2,5 - 16 x 2 - 20 x 2,5	10	50	13,26
87.19.205	20 x 2,5 - 16 x 2,25 - 20 x 2,5	10	50	13,26
87.19.250	25 x 2,5 - 16 x 2 - 25 x 2,5	5	20	19,80
87.19.251	25 x 2,5 - 18 x 2 - 25 x 2,5	5	20	21,39
87.19.252	25 x 2,5 - 20 x 2 - 25 x 2,5	5	20	18,68
87.19.260	26 x 3 - 20 x 2,5 - 26 x 3	5	20	18,68
87.19.261	26 x 3 - 16 x 2 - 26 x 3	5	30	18,20
87.19.262	26 x 3 - 18 x 2 - 26 x 3	5	30	18,68
87.19.263	26 x 3 - 20 x 2 - 26 x 3	5	20	18,20
87.19.320	32 x 3 - 16 x 2 - 32 x 3	1	20	25,65
87.19.321	32 x 3 - 18 x 2 - 32 x 3	1	20	25,65
87.19.322	32 x 3 - 20 x 2 - 32 x 3	1	20	25,65
87.19.323	32 x 3 - 20 x 2,5 - 32 x 3	1	20	25,65
87.19.324	32 x 3 - 25 x 2,5 - 32 x 3	1	20	25,65
87.19.326	32 x 3 - 26 x 3 - 32 x 3	1	20	25,65
87.19.401	40 x 3,5 - 25 x 2,5 - 40 x 3,5	1	10	46,20
87.19.402	40 x 3,5 - 26 x 3 - 40 x 3,5	1	10	46,20
87.19.403	40 x 3,5 - 32 x 3 - 40 x 3,5	1	10	46,20
87.19.500	50 x 4 - 26 x 3 - 50 x 4	1	5	72,10
87.19.501	50 x 4 - 32 x 3 - 50 x 4	1	5	72,10
87.19.502	50 x 4 - 40 x 3,5 - 50 x 4	1	5	73,44

T- STÜCK REDUZIERT
REDUCING TEE

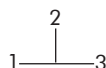

ART. NUMMER
ARTICLE NUMBER

ABMESSUNG
SIZE

10 50

EURO

87.20.160	16 x 2 - 14 x 2 - 14 x 2	10	50	10,92
87.20.181	18 x 2 - 16 x 2 - 16 x 2	10	50	12,88
87.20.202	20 x 2 - 16 x 2 - 16 x 2	10	50	11,50
87.20.203	20 x 2 - 18 x 2 - 18 x 2	10	50	12,88
87.20.204	20 x 2 - 16 x 2 - 18 x 2	10	50	12,88
87.20.205	20 x 2 - 20 x 2 - 14 x 2	10	50	12,88
87.20.206	20 x 2 - 20 x 2 - 16 x 2	10	50	12,45
87.20.210	20 x 2,5 - 16 x 2,25 - 16 x 2,25	10	50	12,88
87.20.250	25 x 2,5 - 16 x 2 - 20 x 2	5	50	18,18
87.20.251	25 x 2,5 - 20 x 2 - 16 x 2	5	20	18,18
87.20.252	25 x 2,5 - 20 x 2 - 20 x 2	5	20	18,18
87.20.253	25 x 2,5 - 25 x 2,5 - 16 x 2	5	20	18,18
87.20.254	25 x 2,5 - 25 x 2,5 - 20 x 2	5	20	18,18
87.20.260	26 x 3 - 16 x 2 - 20 x 2	5	30	17,30
87.20.262	26 x 3 - 18 x 2 - 18 x 2	5	30	18,20
87.20.264	26 x 3 - 20 x 2 - 16 x 2	5	30	18,20
87.20.265	26 x 3 - 20 x 2 - 20 x 2	5	30	18,20
87.20.267	26 x 3 - 20 x 2,5 - 20 x 2,5	5	20	18,20
87.20.268	26 x 3 - 26 x 3 - 20 x 2,5	5	20	18,20
87.20.269	26 x 3 - 26 x 3 - 16 x 2	5	30	18,20
87.20.270	26 x 3 - 26 x 3 - 20 x 2	5	30	18,20
87.20.320	32 x 3 - 20 x 2 - 26 x 3	1	20	25,65
87.20.321	32 x 3 - 20 x 2,5 - 26 x 3	1	20	25,65
87.20.323	32 x 3 - 25 x 2,5 - 25 x 2,5	1	20	25,65
87.20.325	32 x 3 - 26 x 3 - 26 x 3	1	20	25,65
87.20.326	32 x 3 - 32 x 3 - 20 x 2	1	20	25,65
87.20.329	32 x 3 - 32 x 3 - 26 x 3	1	20	25,65
87.20.400	40 x 3,5 - 32 x 3 - 32 x 3	1	20	46,19
87.20.403	40 x 3,5 - 26 x 3 - 32 x 3	1	10	46,19
87.20.404	40 x 3,5 - 40 x 3,5 - 26 x 3	1	10	46,19
87.20.405	40 x 3,5 - 40 x 3,5 - 32 x 3	1	10	46,19
87.20.500	50 x 4 - 40 x 3,5 - 40 x 3,5	1	10	81,64
87.20.501	50 x 4 - 32 x 3 - 40 x 3,5	1	10	81,64
87.20.502	50 x 4 - 50 x 4 - 32 x 3	1	5	81,64
87.20.503	50 x 4 - 50 x 4 - 40 x 3,5	1	5	81,64

T- STÜCK ERWEITERT

TEE ENLARGED
MIDDLE SECTION



ART. NUMMER
ARTICLE NUMBER

ABMESSUNG
SIZE

10 50

EURO

87.21.140	14 x 2 - 16 x 2 - 14 x 2	10	50	13,08
87.21.160	16 x 2 - 18 x 2 - 16 x 2	10	50	13,08
87.21.161	16 x 2 - 20 x 2 - 16 x 2	10	50	12,15
87.21.162	16 x 2 - 20 x 2,5 - 16 x 2	10	50	13,08
87.21.163	16 x 2,25 - 20 x 2,5 - 16 x 2,25	10	50	13,08
87.21.200	20 x 2 - 25 x 2,5 - 20 x 2	5	20	18,00
87.21.201	20 x 2 - 26 x 3 - 20 x 2	5	30	18,00
87.21.202	20 x 2,5 - 26 x 3 - 20 x 2,5	5	20	18,00
87.21.250	25 x 2,5 - 32 x 3 - 25 x 2,5	1	20	25,46
87.21.260	26 x 3 - 32 x 3 - 26 x 3	1	20	25,46

• AUF ANFRAGE - ON REQUEST

SONDERABMESSUNGEN - SPECIAL SIZES



T-STÜCK MIT AG
MALE TEE

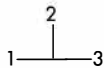

ART. NUMMER ARTICLE NUMBER	ABMESSUNG SIZE			EURO
87.22.160	16 x 2 - 1/2" - 16 x 2	10	50	11,70
87.22.161	16 x 2,25 - 1/2" - 16 x 2,25	10	50	11,70
87.22.180	18 x 2 - 1/2" - 18 x 2	10	50	12,41
87.22.200	20 x 2 - 1/2" - 20 x 2	10	40	11,70
87.22.201	20 x 2 - 3/4" - 20 x 2	10	40	14,90
87.22.202	20 x 2,5 - 1/2" - 20 x 2,5	10	40	13,86
87.22.251	25 x 2,5 - 3/4" - 25 x 2,5	5	20	17,53
87.22.252	25 x 2,5 - 1" - 25 x 2,5	5	20	20,60
87.22.260	26 x 3 - 1/2" - 26 x 3	5	20	16,05
87.22.261	26 x 3 - 3/4" - 26 x 3	5	20	16,05
87.22.262	26 x 3 - 1" - 26 x 3	5	20	19,30
87.22.320	32 x 3 - 3/4" - 32 x 3	1	20	21,65
87.22.321	32 x 3 - 1" - 32 x 3	1	15	22,05
87.22.500	50 x 4 - 1 1/4" - 50 x 4	1	5	70,41
87.22.501	50 x 4 - 1 1/2" - 50 x 4	1	5	71,14

WANDWINKEL
KURZ 90°

WALLPLATE ELBOW-SHORT
90°



3 FACH BOHRUNG • 3 FIXING HOLES

ART. NUMMER ARTICLE NUMBER	ABMESSUNG SIZE			EURO
87.24.140	14 x 2 - 1/2"	h. 39 mm	10 50	9,54
87.24.145	16 x 2 - 3/8"	h. 39 mm	10 50	10,58
87.24.159	16 x 2,25 - 1/2"	h. 39 mm	10 50	8,84
87.24.160	16 x 2 - 1/2"	h. 39 mm	10 50	7,96
87.24.161	16 x 2 - 1/2"	h. 52 mm	10 40	9,93
87.24.180	18 x 2 - 1/2"	h. 52 mm	10 40	10,10
87.24.200	20 x 2 - 1/2"	h. 52 mm	10 40	9,55
87.24.201	20 x 2 - 3/4"	h. 52 mm	10 30	12,26
87.24.202	20 x 2,5 - 1/2"	h. 52 mm	10 40	10,29
87.24.203	20 x 2,5 - 3/4"	h. 52 mm	10 30	12,26
87.24.250	25 x 2,5 - 3/4"	h. 52 mm	5 25	12,26
87.24.260	26 x 3 - 3/4"	h. 52 mm	5 25	12,73

* Für Montageschienen - Seite 65/66 * For mounting plates - Page 65/66

* Per montaggio piastra - Pag. 65/66

- Wichtig: Vor dem Wandeinbau verpressen!
- Important: To be pressed ahead wall installation
- Importante: Deve essere pressato prima dell'installazione a muro

T-STÜCK MIT IG
FEMALE TEE

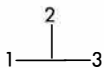

ART. NUMMER ARTICLE NUMBER	ABMESSUNG SIZE			EURO
87.23.160	16 x 2 - 1/2" - 16 x 2	10	50	10,85
87.23.161	16 x 2,25 - 1/2" - 16 x 2,25	10	50	11,78
87.23.180	18 x 2 - 1/2" - 18 x 2	10	50	11,56
87.23.181	18 x 2 - 3/4" - 18 x 2	10	50	15,91
87.23.200	20 x 2 - 1/2" - 20 x 2	10	40	11,60
87.23.201	20 x 2 - 3/4" - 20 x 2	10	40	15,35
87.23.202	20 x 2,5 - 1/2" - 20 x 2,5	10	40	13,87
87.23.203	20 x 2,5 - 3/4" - 20 x 2,5	10	40	16,62
87.23.250	25 x 2,5 - 1/2" - 25 x 2,5	5	20	16,33
87.23.252	25 x 2,5 - 3/4" - 25 x 2,5	5	20	17,00
87.23.260	26 x 3 - 1/2" - 26 x 3	5	20	15,70
87.23.263	26 x 3 - 3/4" - 26 x 3	5	20	16,65
87.23.320	32 x 3 - 1/2" - 32 x 3	1	20	24,35
87.23.321	32 x 3 - 3/4" - 32 x 3	1	20	25,25
87.23.322	32 x 3 - 1" - 32 x 3	1	15	23,40
87.23.323	32 x 3 - 1 1/4" - 32 x 3	1	15	32,40
87.23.400	40 x 3,5 - 1" - 40 x 3,5	1	15	44,30
87.23.401	40 x 3,5 - 1 1/4" - 40 x 3,5	1	10	44,30
87.23.500	50 x 4 - 1 1/4" - 50 x 4	1	5	61,36
87.23.501	50 x 4 - 1 1/2" - 50 x 4	1	5	73,00
87.23.631	63 x 6 - 1" - 63 x 6	1	5	203,00
87.23.632	63 x 6 - 1 1/2" - 63 x 6	1	5	203,00

WANDWINKEL KURZ DOPPELT

WALLPLATE ELBOW-DOUBLE SHORT



ART. NUMMER ARTICLE NUMBER	ABMESSUNG SIZE			EURO
87.25.160	16 x 2 - 1/2" - 16 x 2	h 52 mm	10 20	15,55
87.25.161	16 x 2,25 - 1/2" - 16 x 2,25	h 52 mm	10 20	14,28
87.25.180	18 x 2 - 1/2" - 18 x 2	h 52 mm	10 20	16,85
87.25.200	20 x 2 - 1/2" - 20 x 2	h 52 mm	10 20	16,85

3 FACH BOHRUNG • 3 FIXING HOLES

• AUF ANFRAGE - ON REQUEST

SONDERABMESSUNGEN - SPECIAL SIZES

WANDWINKEL LANG 90°
WALLPLATE ELBOW-LONG 90°



ART. NUMMER ARTICLE NUMBER	ABMESSUNG SIZE				EURO
87.26.160	16 x 2 - 1/2"	h 78 mm	5	25	14,04
87.26.200	20 x 2 - 1/2"	h 78 mm	5	25	14,98
87.26.201	20 x 2,5 - 1/2"	h 78 mm	5	25	15,54

3 FACH BOHRUNG • 3 FIXING HOLES

WANDDURCHFÜHRUNG
MIT VERDREHSCHUTZ
3/4" AG x 1/2" IG
CISTERN CONNECTOR 3/4" M x 1/2"



ART. NUMMER ARTICLE NUMBER	ABMESSUNG SIZE				EURO
87.33.105	16 x 2	h 78 mm	5	25	16,22
87.33.115	20 x 2	h 78 mm	5	25	16,22

3 FACH BOHRUNG • 3 FIXING HOLES

WANDWINKEL FÜR
SERIENVERBINDUNGEN
WALLPLATE ELBOW
FOR SERIES CONNECTIONS

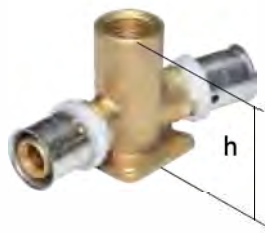

ART. NUMMER ARTICLE NUMBER	ABMESSUNG SIZE				EURO
87.26.205	16 x 2 - 1/2" F - 16 x 2	h 52 mm	10	20	16,87
87.26.210	20 x 2 - 1/2" F - 20 x 2	h 52 mm	10	20	17,23

3 FACH BOHRUNG • 3 FIXING HOLES

UP - SPÜLKASTENWINKEL
WC CISTERN ELBOW



ART. NUMMER ARTICLE NUMBER	ABMESSUNG SIZE				EURO
87.28.160	16 x 2 - 1/2"		5	30	19,30
87.28.180	18 x 2 - 1/2"		5	30	20,60
87.28.200	20 x 2 - 1/2"		5	30	20,60

WANDWINKEL DOPPELT U-FORM
WALLPLATE ELBOW U-SHAPED



ART. NUMMER ARTICLE NUMBER ARTICOLO	ABMESSUNG SIZE MISURE				EURO
87.27.160	16x2 - 1/2" - 16x2		5	15	21,16
87.27.200	20x2 - 1/2" - 20x2		5	15	21,70

UP - SPÜLKASTEN T-STÜCK
WC CISTERN T-PIECE





ART. NUMMER ARTICLE NUMBER ARTICOLO	ABMESSUNG SIZE MISURE				EURO
87.29.160	16 x 2 - 1/2" - 16 x 2		10	30	23,40
87.29.200	20 x 2 - 1/2" - 20 x 2		10	30	24,34

SONDERABMESSUNGEN - SPECIAL SIZES



WINKEL 45°
ELBOW 45°





ART. NUMMER ARTICLE NUMBER	ABMESSUNG SIZE			EURO
87.30.250	25 x 2,5	5	40	19,70
87.30.260	26 x 3	5	40	19,70
87.30.320	32 x 3	1	20	22,45
87.30.400	40 x 3,5	1	20	40,60
87.30.500	50 x 4	1	5	64,58

ENDSTÜCK FÜR LEITUNGSTEST
FÜR THERMOMETER



TEST PLANT FITTING FOR THERMOMETER

ART. NUMMER ARTICLE NUMBER ARTICOLO	ABMESSUNG SIZE MISURE			EURO
87.80.494	1/2" F. - 16 x 2	10	100	11,50
87.80.495	1/2" F. - 20 x 2	10	100	11,50



PRÜFUNG-STOPFEN ROT
PRESSURE TEST PLUGS - RED



ART. NUMMER ARTICLE NUMBER	ABMESSUNG SIZE			EURO
87.80.490	1/2" M		50	1,12

PRESSSTOPFEN
STOP END



ART. NUMMER ARTICLE NUMBER	ABMESSUNG SIZE			EURO
87.31.140	14x2	10	150	5,99
87.31.160	16x2	10	150	5,99
87.31.180	18x2	10	150	5,99
87.31.200	20x2	10	150	7,18
87.31.250	25x2,5	5	100	9,59
87.31.260	26x3	5	100	9,59
87.31.320	32x3	1	60	11,22
87.31.400	40x3,5	1	40	20,40
87.31.500	50x4	1	30	34,01

PRÜFUNG-STOPFEN BLAU
PRESSURE TEST PLUGS - BLUE





ART. NUMMER ARTICLE NUMBER	ABMESSUNG SIZE			EURO
87.80.491	1/2" M		50	1,12

WINKELVERSCHRAUBUNG
MIT AG 90°





MALE ANGLE SCREW
CONNECTOR 90°

ART. NUMMER ARTICLE NUMBER	ABMESSUNG SIZE			EURO
87.34.160	16x2 - 1/2"	10	40	15,15
87.34.200	20x2 - 1/2"	10	40	15,15
87.34.201	20x2 - 3/4"	10	30	15,15

• AUF ANFRAGE - ON REQUEST
SONDERABMESSUNGEN - SPECIAL SIZES

WINKELVERSCHRAUBUNG MIT IG 90°
FEMALE ANGLE SCREW CONNECTOR 90°





ART. NUMMER ARTICLE NUMBER	ABMESSUNG SIZE			EURO
87.35.160	16 x 2 - 1/2"	10	40	17,42
87.35.200	20 x 2 - 1/2"	10	40	17,42
87.35.201	20 x 2 - 3/4"	10	30	19,71

ANSCHLUSSPRESSVERSCHRAUBUNG
MIT EUROKONUS BLANK





CONNECTING SCREW FITTING
WITH EURO CONE RAW

ART. NUMMER ARTICLE NUMBER	ABMESSUNG SIZE			EURO
87.39.160	16 x 2 - 3/4"	10	100	9,55
87.39.180	18 x 2 - 3/4"	10	100	10,77
87.39.200	20 x 2 - 3/4"	10	100	10,17
87.39.260	26 x 3 - 1"	10	70	13,90
87.39.265	32 x 3 - 1"	5	50	18,03

PRESSVERSCHRAUBUNG MIT IG FLACHD.
FEMALE SCREW FITTING, FLAT SEAL





ART. NUMMER ARTICLE NUMBER	ABMESSUNG SIZE			EURO
87.36.160	16 x 2 - 1/2"	10	80	15,78
87.36.161	16 x 2 - 3/4"	10	50	16,20
87.36.200	20 x 2 - 1/2"	10	50	17,00
87.36.201	20 x 2 - 3/4"	10	40	17,70
87.36.260	26 x 3 - 3/4"	5	40	26,20
87.36.261	26 x 3 - 1"	5	30	26,60
87.36.320	32 x 3 - 1"	1	30	32,90

Konisch - Tapered - Tenuta conica

ANSCHLUSSPRESSVERSCHRAUBUNG
MIT EUROKONUS VERN.





CONNECTING SCREW FITTING
WITH EURO CONE NP.

ART. NUMMER ARTICLE NUMBER	ABMESSUNG SIZE			EURO
87.40.160	16 x 2 - 3/4"	10	100	9,55
87.40.180	18 x 2 - 3/4"	10	100	10,77
87.40.200	20 x 2 - 3/4"	10	100	10,17
87.40.260	26 x 3 - 1"	10	70	13,93
87.40.265	32 x 3 - 1"	5	50	18,03



PRESSVERSCHRAUBUNG MIT AG, KONISCH
MALE SCREW FITTING, TAPERED



ART. NUMMER ARTICLE NUMBER	ABMESSUNG SIZE			EURO
87.37.160	16 x 2 - 1/2"	10	80	15,75
87.37.161	16 x 2 - 3/4"	10	50	16,22
87.37.200	20 x 2 - 1/2"	10	50	17,00
87.37.201	20 x 2 - 3/4"	10	40	17,70
87.37.260	26 x 3 - 3/4"	5	40	25,25
87.37.261	26 x 3 - 1"	5	30	25,80
87.37.320	32 x 3 - 1"	1	30	37,08

ÜBERGANGSPRESSVERSCHRAUBUNG FLACHD.
SCREW CONNECTOR, FLAT SEAL



ART. NUMMER ARTICLE NUMBER	ABMESSUNG SIZE			EURO
87.42.150	16 x 2 - 1/2"	10	150	7,01
87.42.160	16 x 2 - 3/4"	10	120	7,96
87.42.180	18 x 2 - 3/4"	10	100	8,26
87.42.200	20 x 2 - 3/4"	10	100	8,56
87.42.260	26 x 3 - 1"	5	80	13,10

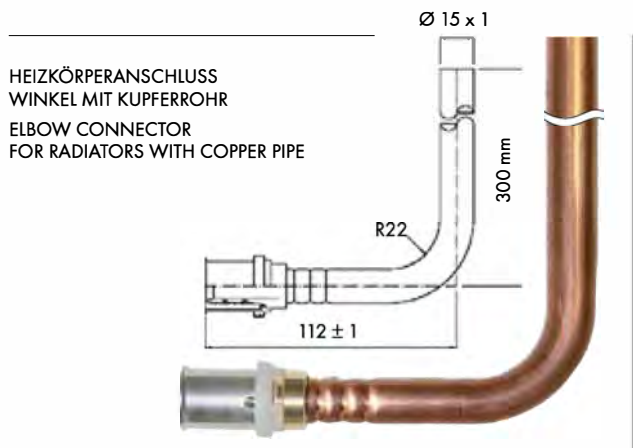

HEIZKÖRPERANSCHLUSS
WINKEL MIT KUPFERROHR
ELBOW CONNECTOR
FOR RADIATORS WITH COPPER PIPE

ART. NUMMER ARTICLE NUMBER	ABMESSUNG SIZE			EURO
87.45.185	18 x 2 - 15 mm - 300 mm			20,45

WANDWINKEL 16 x 2 - KUPFERROHR 15 MM
DOUBLE BENT 16 x 2 - COPPER PIPE 15 MM



ART. NUMMER ARTICLE NUMBER ARTICOLO	ABMESSUNG SIZE MISURE			EURO
87.46.250	15 mm - 16 x 2	1	10	35,57

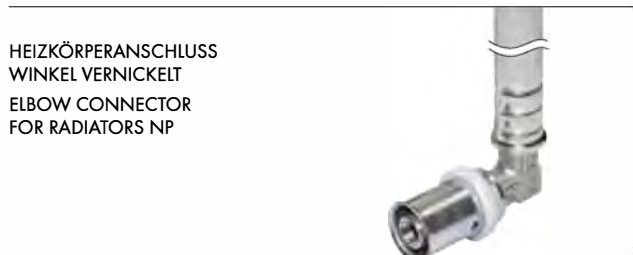
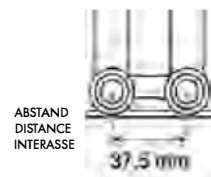

HEIZKÖRPERANSCHLUSS
WINKEL VERNICKELT
ELBOW CONNECTOR
FOR RADIATORS NP

ART. NUMMER ARTICLE NUMBER	ABMESSUNG SIZE			EURO
87.45.140	14 x 2 - 15 mm - 300 mm	2	30	18,68
87.45.160	16 x 2 - 15 mm - 300 mm	2	30	15,91
87.45.161	16 x 2 - 15 mm - 1100 mm	2		31,82
87.45.180	18 x 2 - 15 mm - 300 mm	2	30	20,54
87.45.200	20 x 2 - 15 mm - 300 mm	2	30	21,09
87.45.201	20 x 2 - 15 mm - 1100 mm	2		39,00

STEIGSTRANG ANBINDESET
MIT 6 ANSCHLÜSSEN
TEE BY-PASS



ART. NUMMER ARTICLE NUMBER	ABMESSUNG SIZE			EURO
87.49.010	16 x 16 x 16	1	15	72,74
87.49.015	20 x 16 x 16	1	15	72,74
87.49.020	20 x 16 x 20	1	15	72,74
87.49.025	20 x 20 x 20	1	15	72,74



HEIZKÖRPERANSCHLUSS
T-STÜCK VERNICKELT
TEE CONNECTOR
FOR RADIATORS NP

ART. NUMMER ARTICLE NUMBER	ABMESSUNG SIZE			EURO
87.46.160	16 x 2 - 15 mm - 300 mm	2	20	20,16
87.46.161	16 x 2 - 15 mm - 1100 mm	2		28,29
87.46.200	20 x 2 - 15 mm - 300 mm	2	20	27,23
87.46.201	20 x 2 - 15 mm - 1100 mm	2		43,87

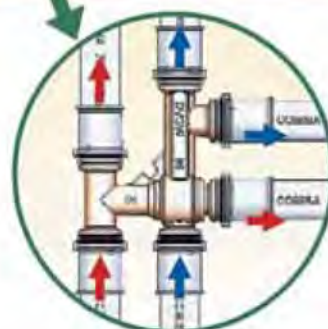
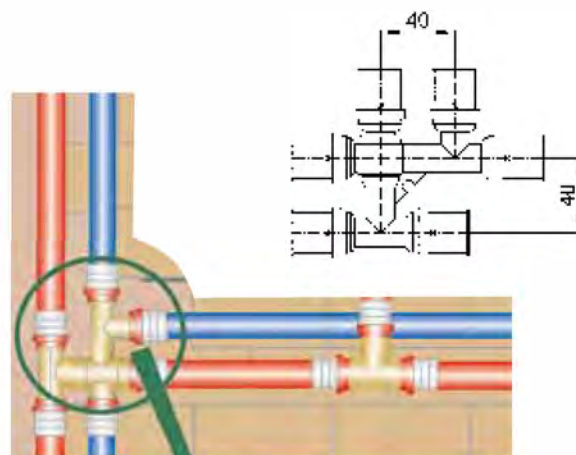

• AUF ANFRAGE - ON REQUEST - SU ORDINAZIONE

PRESS KUGELHAHN FLÜGELGRIFF
PRESS BALL VALVE BUTTERFLY HANDLE



ART. NUMMER ARTICLE NUMBER	ABMESSUNG SIZE			EURO
87.50.005	16 x 2	10	30	24,35
87.50.010	20 x 2	10	30	26,20



KUGELHAHN FÜR UNTERPUTZINSTALLATION 1/2"
MIT KAPPE
BUILT-IN BALL VALVE 1/2" WITH CAP



ART. NUMMER ARTICLE NUMBER	ABMESSUNG SIZE		EURO
87.50.042	16 x 2	10	33,71
87.50.044	16 x 2,25	10	33,71
87.50.047	18 x 2	10	34,12
87.50.043	20 x 2	10	34,64
87.50.045	20 x 2,5	10	34,64
NEW 87.50.049	20 x 2 - 16 x 2	10	34,64

PRESS KUGELHAHN FLÜGELGRIFF
PRESS BALL VALVE BUTTERFLY HANDLE



ART. NUMMER ARTICLE NUMBER	ABMESSUNG SIZE			EURO
87.50.014	16 x 2 - 1/2" F	10	30	17,67
87.50.015	20 x 2 - 1/2" F	10	30	18,03

EINBAU-KUGELHAHN FÜR UNTERPUTZINSTALLATION
MIT KAPPE UND AUSTAUSCHBAREM OBERTEIL
BUILT-IN BALL VALVE WITH CAP (INSPECTIONABLE)



ART. NUMMER ARTICLE NUMBER		EURO
87.50.050	30	46,80

EINBAU-KUGELHAHN FÜR UNTERPUTZINSTALLATION
MIT GRIFF UND AUSTAUSCHBAREM OBERTEIL
BUILT-IN BALL VALVE WITH HANDLE (INSPECTIONABLE)



ART. NUMMER ARTICLE NUMBER		EURO
87.50.055	30	59,90

SONDERABMESSUNGEN - SPECIAL SIZES



EINBAU-KUGELHAHN FÜR UNTERPUTZINSTALLATION
MIT HEBEL UND AUSTAUSCHBAREM OBERTEIL

BUILT-IN BALL VALVE WITH FLAT
HANDLE (INSPECTIONABLE)



ART. NUMBER
ARTICLE NUMBER
ARTICOLO

EURO

87.50.060

63,65

PRESS-STECKVERBINDUNG (2 STÜCKE)
QUICK PRESS CONNECTION (2 PIECES)



ART. NUMBER
ARTICLE NUMBER
ARTICOLO

ABMESSUNG
SIZE
MISURE

EURO

87.50.100 16 x 2

12,92

87.50.101 16 x 2,25

12,92

87.50.105 20 x 2

12,92

87.50.106 20 x 2,5

12,92

UNTERPUTZVERLÄNGERUNG PASSEND
FÜR UP VENTILE 87.50.050 - 055 - 060

EXTENSION KIT FOR BUILT-IN BALL VALVE
(INSPECTIONABLE) FOR ART. 87.50.050 - 055 - 060



ART. NUMBER
ARTICLE NUMBER

EURO

87.50.065

21,21

STECKANSCHLUSS MIT MUFFENGEWINDE
(2 STÜCKE)

FEMALE QUICK CONNECTION
(2 PIECES)



ART. NUMBER
ARTICLE NUMBER

ABMESSUNG
SIZE

EURO

87.50.080 1/2"

11,79

87.50.090 3/4"

15,54

UNTERPUTZVERLÄNGERUNG PASSEND
FÜR UP-VENTILE 87.50.042-43-44-45-47

EXTENSION KIT FOR BUILT-IN BALL VALVE
FOR ART. 87.50.042-43-44-45-47



ART. NUMBER
ARTICLE NUMBER

EURO

87.50.046

21,21

STECKANSCHLUSS MIT AUSSENGEWINDE
(2 STÜCKE)

MALE QUICK CONNECTION
(2 PIECES)



ART. NUMBER
ARTICLE NUMBER

ABMESSUNG
SIZE

EURO

87.50.085 1/2"

11,78

87.50.095 3/4"

15,54

SONDERABMESSUNGEN - SPECIAL SIZES

O-RINGS



ART. NUMMER ARTICLE NUMBER	ABMESSUNG SIZE	EURO
87.44.160	16 x 2	0,17
87.44.170	17 x 2	0,19
87.44.180	18 x 2	0,19
87.44.200	20 x 2	0,20
87.44.250	25 x 2,5	0,25
87.44.260	26 x 3	0,25
87.44.320	32 x 3	0,27
87.44.400	40 x 3,5	0,32
87.44.500	50 x 4	0,85
87.44.505	63 x 6	1,50

PRESSÜBERGANG + KLEMMVERSCHRAUBUNG
NIPPLES PRESS X COMPRESSION



ART. NUMMER ARTICLE NUMBER	ABMESSUNG SIZE			EURO
87.47.020	16 x 2 - 15 mm •	10	140	8,62
87.47.030	20 x 2 - 22 mm •	10	80	16,85
87.47.035	26 x 3 - 22 mm •	10	70	19,10
87.47.040	26 x 3 - 28 mm •	10	50	21,55

PRESSHÜLSEN AUS EDELSTAHL
PRESSURE COLLARS IN STAINLESS STEEL



ART. NUMMER ARTICLE NUMBER	ABMESSUNG SIZE	EURO
87.43.140	14	1,09
87.43.160	16	1,09
87.43.170	17	1,36
87.43.180	18	1,36
87.43.200	20	1,36
87.43.250	25	3,75
87.43.260	26	2,02
87.43.320	32	2,32
87.43.400	40	5,05
87.43.500	50	6,10
87.43.505	63	14,67

PRESSÜBERGANG + EINSATZ
NIPPLES PRESS + INSERT



ART. NUMMER ARTICLE NUMBER	ABMESSUNG SIZE			EURO
87.47.055	16 x 2 - 12 mm vern. - NP •	10	200	13,11
87.47.060	16 x 2 - 15 mm •	10	150	12,55
87.47.070	20 x 2 - 22 mm •	10	150	14,98

PRESSWINKEL + KLEMMVERSCHRAUBUNG
ELBOW PRESS X COMPRESSION





ART. NUMMER ARTICLE NUMBER	ABMESSUNG SIZE			EURO
87.47.110	16 x 2 -10 mm •	10	150	10,65
87.47.115	16 x 2 -15 mm •	10	100	10,65

• AUF ANFRAGE - ON REQUEST
SONDERABMESSUNGEN - SPECIAL SIZES



MONTAGEPLATTE (NORMALE AUSFÜHRUNG) MIT 4 BEFESTIGUNGSSCHRAUBEN
MOUNTING PLATE WITH 4 SCREWS

ART. NUMMER ARTICLE NUMBER	ABMESSUNG SIZE			EURO
87.49.600	153/76 mm	10	50	4,43

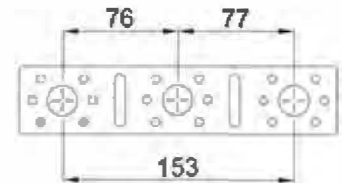

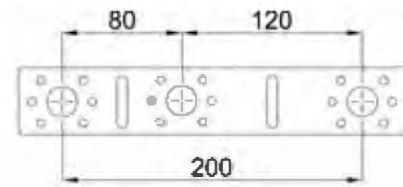

MONTAGEPLATTE (NORMALE AUSFÜHRUNG) MIT 4 BEFESTIGUNGSSCHRAUBEN
MOUNTING PLATE WITH 4 SCREWS

ART. NUMMER ARTICLE NUMBER	ABMESSUNG SIZE			EURO
87.49.605	120/200 mm	10	50	6,72



WEISSE KUNSTOFFPLATTE MIT 6 BEFESTIGUNGSSCHRAUBEN
PLASTIC WHITE PLATE WITH 6 SCREWS

ART. NUMMER ARTICLE NUMBER	ABMESSUNG SIZE			EURO
87.49.601	153/76 mm	10	50	3,37

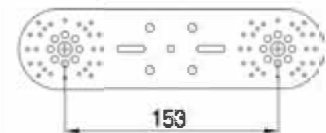

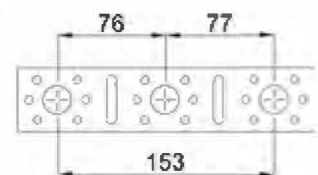

MONTAGESCHIENE (EINBAUTEIL) MIT 6 BEFESTIGUNGSSCHRAUBEN
BUILT-IN MOUNTING PLATE WITH 6 SCREWS

ART. NUMMER ARTICLE NUMBER	ABMESSUNG SIZE			EURO
87.49.610	153/76 mm	10	22	14,90



SCHIENE - GERADE
STRAIGHT MOUNTING PLATE



ART. NUMMER ARTICLE NUMBER	ABMESSUNG SIZE			EURO
87.49.650	h 56 mm	1	20	8,09

SCHIENE - GEBOGEN
BENT MOUNTING PLATE



ART. NUMMER ARTICLE NUMBER	ABMESSUNG SIZE			EURO
87.49.655	h 56 mm	1	20	12,63

FIXIERPLÄTTCHEN
BACKING PLATES



ART. NUMMER ARTICLE NUMBER	EURO
87.49.660	0,71

SCHALLTRENNER
SOUND-SHIELD



ART. NUMMER ARTICLE NUMBER	EURO
87.49.665	8,29

SCHALLSCHUTZSET "ISOLATION"
FÜR WANDWINKEL LANG 1/2"
AUS SCHWARZEM SPEZIALKUNSTSTOFF

SOUNDPROOF ELEMENT
FOR WALLPLATE ELBOW 1/2" LONG



ART. NUMMER ARTICLE NUMBER			EURO
87.49.686	10	40	10,87

ISO-KAPPE
SOUND-CAP



ART. NUMMER ARTICLE NUMBER	EURO
87.49.670	2,02

BLECHSCHRAUBEN 4,8 x 16
SCREWS 4,8 x 16



STK./PACKET PCS./PACKAGE	ART. NUMMER ARTICLE NUMBER	ABMESSUNG SIZE
100		



ART. NUMMER ARTICLE NUMBER	ABMESSUNG SIZE	EURO
87.49.675	4,8 x 16	7,07

SCHALLSCHUTZSET "ISOLATION"
FÜR WANDWINKEL KURZ 1/2" H.52MM
AUS SCHWARZEM SPEZIALKUNSTSTOFF

SOUNDPROOF ELEMENT
FOR WALLPLATE ELBOW 1/2"
SHORT H 52 MM



ART. NUMMER ARTICLE NUMBER			EURO
87.49.685	10	50	7,38

BIEGEZANGE
PLIERS





ART. NUMMER ARTICLE NUMBER			EURO
87.49.680	1	1	229,84

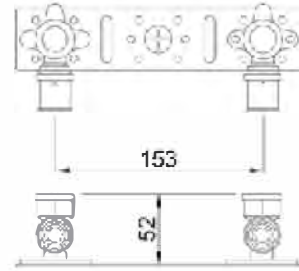

WANDWINKEL MONTIERT IM SET
WALLPLATE ELBOW ASSEMBLED IN SET



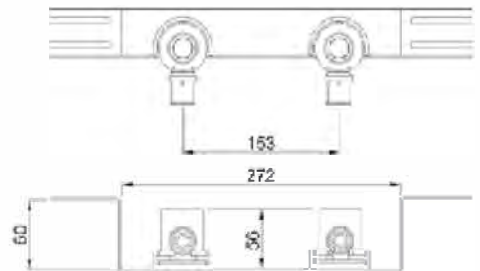

ART. NUMMER ARTICLE NUMBER	ABMESSUNG SIZE			EURO
87.54.005	16 x 2 - 1/2"	1	10	24,75
87.54.019	20 x 2 - 1/2"	1	10	25,65
87.54.020	20 x 2 - 3/4"	1	8	29,75

KOMPLETTSET BESTEHEND AUS 2 WANDWINKELN
KURZ 1/2" - 16 x 2 H. 52 mm 2 ISOLATIONEN SCHALLSCHUTZSET
AUS SCHWARZEM SPEZIALKUNSTSTOFF
MONTIERT AUF MONTAGESCHIENE





WALLPLATE ELBOW 16 x 2 - 1/2" H. 52 mm
WITH SOUNDPROOF ELEMENTS ASSEMBLED IN SET

ART. NUMMER ARTICLE NUMBER	ABMESSUNG SIZE			EURO
87.54.030	16 x 2 1/2"	10	20	67,39

MONTAGEPLATTE MIT 2 GEGENEINANDERE
VERDREHTEN T-FITTINGS FÜR SERIENVERBINDUNGEN

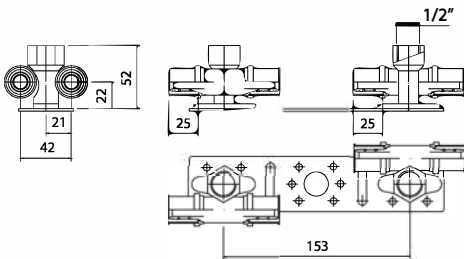
DISALIGNED TEE FITTINGS, ON MOUNTING PLATE,
FOR MULTIPLE CONNECTIONS





ART. NUMMER ARTICLE NUMBER	ABMESSUNG SIZE			EURO
87.54.034	16 x 2 - 1/2"			44,21
87.54.035	20 x 2 - 1/2"			42,56

MONTAGEPLATTE MIT 2 GEGENEINANDERE
VERDREHTEN ENDSTÜCKEN

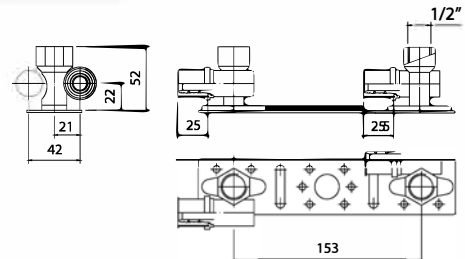
DISALIGNED END FITTINGS, ON MOUNTING PLATE



ART. NUMMER ARTICLE NUMBER	ABMESSUNG SIZE			EURO
87.54.039	16 x 2 - 1/2"			42,08
87.54.040	20 x 2 - 1/2"			42,08

MONTAGEINHEIT KOMPLETT MONTIERT MIT 2 DECKENWINKELN
ABSTAND 76 mm

SANITARY MOUNTING PLATE ASSEMBLED
WITH 2 WALLPLATE ELBOWS, DISTANCE 76 mm

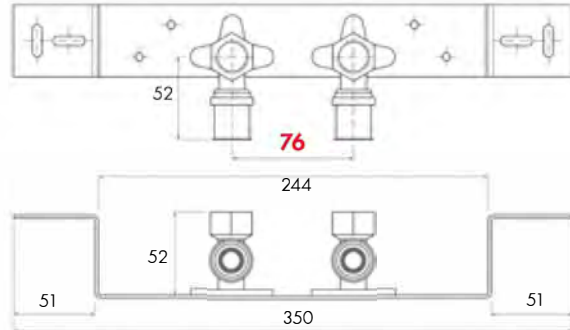

ART. NUMMER ARTICLE NUMBER	ABMESSUNG SIZE			EURO
87.54.060	1/2" - 16 x 2	1	15	52,85
87.54.061	1/2" - 20 x 2	1	15	54,09

MONTAGEINHEIT KOMPLETT MONTIERT MIT 2 DECKENWINKELN
ABSTAND 152 mm

SANITARY MOUNTING PLATE ASSEMBLED
WITH 2 WALLPLATE ELBOWS, DISTANCE 152 mm

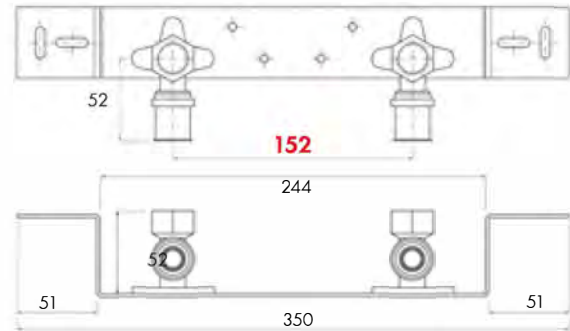

ART. NUMMER ARTICLE NUMBER	ABMESSUNG SIZE			EURO
87.54.065	1/2" - 16 x 2	1	15	52,85
87.54.066	1/2" - 20 x 2	1	15	54,09



MONTAGEINHEIT NICHT MONTIERT
MIT 2 DECKENWINKELN
UND 6 SCHRAUBENSETS

SANITARY MOUNTING PLATE
WITH 2 WALLPLATE ELBOWS,
WITH 6 SCREWS AND NUTS NOT ASSEMBLED

ART. NUMMER ARTICLE NUMBER	ABMESSUNG SIZE			EURO
87.54.070	1/2" - 16 x 2	1	15	51,28
87.54.071	1/2" - 20 x 2	1	15	52,51

MONTAGESCHIENE, ABSTAND 76 - 152 mm
MIT 6 SCHRAUBENSETS

SANITARY MOUNTING PLATE, DISTANCE 76 - 152 mm
WITH 6 SCREWS AND NUTS

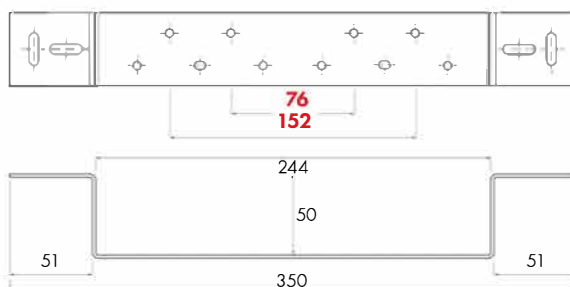

ART. NUMMER ARTICLE NUMBER	EURO
87.54.075	30,60

COMISA

EUROKONO



GALVANISCH BEHANDELTE VERSCHRAUBUNGEN FÜR METALLVERBUNDRÖHR
MIT KLEMMRINGVERSCHRAUBUNGEN
PLATED SCREW FITTINGS FOR MULTILAYER PIPE WITH ADAPTOR

MESSING - BRASS UNI EN 12164/12165 - CW 617N



DW-8501BT0290





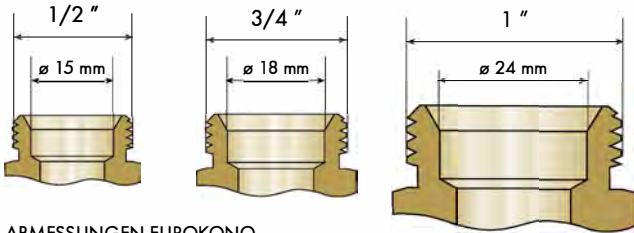

KUPPLUNGSSTÜCK
MIT AG UND O-RING DICHTEND
MALE STRAIGHT COUPLING
WITH O-RING SEAL



ABMESSUNGEN EUROKONO
EUROKONO SIZES



ART. NUMMER ARTICLE NUMBER	ABMESSUNG SIZE			EURO
88.01.037	3/4" euro x 1/2" Messing - Yellow brass - Giallo	10	100	2,85
88.01.038	3/4" euro x 1/2" Vernickelt - Nickel plated - Nichelato	10	100	2,66



KUPPLUNG DOPPELT
DOUBLE COUPLING



KUPPLUNGSTÜCK MIT IG
FEMALE STRAIGHT COUPLING



ART. NUMMER ARTICLE NUMBER	ABMESSUNG SIZE			EURO
88.01.005	1/2" euro	10	200	1,62
88.01.010	3/4" euro	10	100	2,46
88.01.015	1" euro	10	80	4,24



ART. NUMMER ARTICLE NUMBER	ABMESSUNG SIZE			EURO
88.01.045	1/2" euro x 1/2"	10	200	2,47
88.01.065	3/4" euro x 1/2"	10	100	3,40
88.01.050	3/4" euro x 3/4"	10	100	4,43
88.01.055	1" euro x 3/4"	10	100	8,14
88.01.060	1" euro x 1"	10	80	6,13

KUPPLUNGSSTÜCK MIT AG ISO 7/2
MALE STRAIGHT COUPLING ISO 7/2



WINKELKUPPLUNG 90°
ELBOW 90°





ART. NUMMER ARTICLE NUMBER	ABMESSUNG SIZE			EURO
88.01.020	1/2" euro x 1/2"	10	200	2,24
88.01.021	3/4" euro x 1/2"	10	100	3,63
88.01.025	3/4" euro x 3/4"	10	100	4,04
88.01.030	1" euro x 3/4"	10	80	4,90
88.01.035	1" euro x 1"	10	80	5,35

ART. NUMMER ARTICLE NUMBER	ABMESSUNG SIZE			EURO
88.01.100	1/2" euro	10	200	2,24
88.01.105	3/4" euro	10	100	4,18
88.01.110	1" euro	10	40	6,28





WINKEL MIT AG 90°
MALE ELBOW 90°



ART. NUMMER ARTICLE NUMBER	ABMESSUNG SIZE			EURO
88.01.115	1/2" euro x 1/2"	10	200	3,17
88.01.130	3/4" euro x 1/2"	10	100	4,43
88.01.120	3/4" euro x 3/4"	10	100	4,70
88.01.125	1" euro x 1"	10	40	7,42
88.01.135	1" euro x 3/4"	10	50	6,10

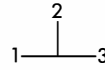

T-STÜCK MIT IG
FEMALE TEE



ART. NUMMER ARTICLE NUMBER	ABMESSUNG SIZE			EURO
88.01.250	1/2" euro x 1/2" x 1/2" euro	10	100	4,43
88.01.270	3/4" euro x 1/2" x 3/4" euro	10	80	5,49
88.01.255	3/4" euro x 3/4" x 3/4" euro	10	80	5,73
88.01.265	1" euro x 3/4" x 1" euro	10	40	9,92
88.01.260	1" euro x 1" x 1" euro	10	40	9,13



WINKEL MIT IG 90°
FEMALE ELBOW 90°



ART. NUMMER ARTICLE NUMBER	ABMESSUNG SIZE			EURO
88.01.150	1/2" euro x 1/2"	10	200	3,25
88.01.165	3/4" euro x 1/2"	10	100	4,98
88.01.155	3/4" euro x 3/4"	10	100	5,73
88.01.170	1" euro x 3/4"	10	50	9,13
88.01.160	1" euro x 1"	10	40	7,82

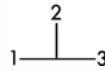

T-STÜCK MIT AG ISO 7/2
MALE TEE ISO 7/2



ART. NUMMER ARTICLE NUMBER	ABMESSUNG SIZE			EURO
88.01.280	1/2" euro x 1/2" x 1/2" euro	10	100	4,04
88.01.285	3/4" euro x 3/4" x 3/4" euro	10	80	6,01
88.01.295	1" euro x 3/4" x 1" euro	10	40	9,92

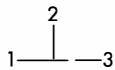

T-STÜCK
TEE



ART. NUMMER ARTICLE NUMBER	ABMESSUNG SIZE			EURO
88.01.200	1/2" euro	10	100	2,88
88.01.205	3/4" euro	10	80	4,98
88.01.210	1" euro	10	40	7,82

WANDWINKEL MIT IG 90°
WALLPLATE ELBOW F. 90°



ART. NUMMER ARTICLE NUMBER	ABMESSUNG SIZE			EURO
88.01.300	1/2" euro x 1/2"	10	80	4,70
88.01.310	3/4" euro x 1/2"	10	60	5,49
88.01.305	3/4" euro x 3/4"	10	60	6,65



3 FACH BOHRUNG • 3 FIXING HOLES

METALLVERBUNDROHR • MULTILAYER PIPE

KLEMMVERSCHRAUBUNG
MIT MUTTER 1/2"

SCREW FITTING
WITH NUT 1/2"





ART. NUMMER ARTICLE NUMBER	ABMESSUNG SIZE			EURO
88.03.016	16 x 2 - 1/2"	10	200	3,33
88.03.017	16 x 2,25 - 1/2"	10	200	3,51

KUPFERROHR • COPPER PIPE

CU-ADAPTER

SCREW FITTING FOR
COPPER PIPE WITH INSERT





ART. NUMMER ARTICLE NUMBER	ABMESSUNG SIZE			EURO
88.03.150	15 x 1/2"	1	300	2,10

METALLVERBUNDROHR • MULTILAYER PIPE

KLEMMVERSCHRAUBUNG
MIT MUTTER 3/4"

SCREW FITTING
WITH NUT 3/4"





ART. NUMMER ARTICLE NUMBER	ABMESSUNG SIZE			EURO
88.03.110	14 x 2 - 3/4"	10	150	3,83
88.03.116	16 x 2 - 3/4"	10	150	3,45
88.03.120	16 x 2,25 - 3/4"	10	100	3,93
88.03.123	17 x 2 - 3/4"	10	100	3,75
88.03.126	18 x 2 - 3/4"	10	150	3,83
88.03.136	20 x 2 - 3/4"	10	150	3,72
88.03.140	20 x 2,5 - 3/4"	10	100	3,93

KUPFERROHR • COPPER PIPE

CU-ADAPTER

SCREW FITTING FOR
COPPER PIPE WITH INSERT





ART. NUMMER ARTICLE NUMBER	ABMESSUNG SIZE			EURO
88.03.170	12 x 1/2"	1	300	7,71
88.03.175	12 x 3/4"	1	200	5,64
88.03.165	15 x 1"	1	100	8,75
88.03.155	18 x 1"	1	100	8,98
88.03.160	22 x 1"	1	100	10,42

METALLVERBUNDROHR • MULTILAYER PIPE

KLEMMVERSCHRAUBUNG
MIT MUTTER 1"

SCREW FITTING
WITH NUT 1"





ART. NUMMER ARTICLE NUMBER	ABMESSUNG SIZE			EURO
88.03.310	16 x 2 - 1"	10	100	7,49
88.03.315	20 x 2 - 1"	10	100	7,49
88.03.321	26 x 3 - 1"	10	100	6,55

PEX-ROHR • PEX-PIPE

KLEMMVERSCHRAUBUNG
MIT MUTTER 3/4"

SCREW FITTING WITH
NUT 3/4"





ART. NUMMER ARTICLE NUMBER	ABMESSUNG SIZE			EURO
88.03.006	12 x 2 - 3/4" PEX	10	100	7,29
88.03.014	14 x 2 - 3/4" PEX	10	100	4,38
88.03.118	16 x 2 - 3/4" PEX	10	100	3,45
88.03.119	17 x 2 - 3/4" PEX	10	150	3,75
88.03.138	20 x 2 - 3/4" PEX	10	100	3,72

SONDERABMESSUNGEN - SPECIAL SIZES - MISURE SPECIALI



KLEMMVERSCHRAUBUNGSKUPPLUNG
 STRAIGHT COUPLING





ART. NUMMER ARTICLE NUMBER	ABMESSUNG SIZE			EURO
88.03.415	16 x 2	10	100	7,42
88.03.416	16 x 2,25	10	100	7,82
88.03.419	14 x 2 *	10	80	10,15
88.03.420	16 x 2 *	10	80	10,15
88.03.421	16 x 2,25 *	10	80	10,15
88.03.425	17 x 2 *	10	80	10,15
88.03.430	18 x 2 *	10	80	10,15
88.03.435	20 x 2 *	10	80	10,15
88.03.436	20 x 2,5 *	10	80	10,42
88.03.445	26 x 3	5	80	16,55
88.03.450	32 x 3	5	80	40,86

• KIT 3/4 EUROKONO

KLEMMVERSCHRAUBUNGSREDUKTION
 STRAIGHT REDUCTION





ART. NUMMER ARTICLE NUMBER	ABMESSUNG SIZE			EURO	
88.03.840	18 x 2 - 16 x 2	*	10	80	10,15
88.03.855	20 x 2 - 16 x 2	*	10	80	10,15
88.03.856	20 x 2,5 - 16 x 2,25	*	10	80	10,15
88.03.860	20 x 2 - 17 x 2	*	10	80	10,15
88.03.865	20 x 2 - 18 x 2	*	5	80	10,15

• KIT 3/4 EUROKONO

KLEMMANSCHLUSSVERSCHRAUBUNG
 MIT AG ISO 7/2

MALE STRAIGHT COUPLING ISO 7/2





ART. NUMMER ARTICLE NUMBER	ABMESSUNG SIZE			EURO
88.03.515	16 x 2 - 1/2"	10	100	4,38
88.03.516	16 x 2,25 - 1/2"	10	100	5,13
88.03.519	14 x 2 - 1/2" *	10	100	6,78
88.03.520	16 x 2 - 1/2" *	10	100	7,17
88.03.521	16 x 2,25 - 1/2" *	10	100	7,17
88.03.525	17 x 2 - 1/2" *	10	100	7,17
88.03.530	18 x 2 - 1/2" *	10	100	7,17
88.03.535	20 x 2 - 1/2" *	5	100	7,17
88.03.536	20 x 2,5 - 1/2" *	5	100	7,17
88.03.540	16 x 2 - 3/4" *	10	80	7,58
88.03.541	16 x 2,25 - 3/4" *	10	80	7,58
88.03.545	17 x 2 - 3/4" *	10	80	7,58
88.03.550	18 x 2 - 3/4" *	10	80	7,58
88.03.555	20 x 2 - 3/4" *	5	80	7,58
88.03.556	20 x 2,5 - 3/4" *	5	80	7,58
88.03.560	26 x 3 - 3/4"	5	50	10,75
88.03.580	26 x 3 - 1"	5	50	12,25
88.03.585	32 x 3 - 1"	5	40	25,00

• KIT 3/4 EUROKONO

KLEMMANSCHLUSSVERSCHRAUBUNG
 MIT AG MIT O-RING DICHTEND NP

MALE STRAIGHT COUPLING
 WITH O-RING SEAL NP





ART. NUMMER ARTICLE NUMBER	ABMESSUNG SIZE			EURO
88.03.610	16 x 2 - 1/2"	10	100	4,98
88.03.616	16 x 2,25 - 1/2"	10	100	5,22
88.03.619	14 x 2 - 1/2" *	10	100	7,29
88.03.620	16 x 2 - 1/2" *	10	100	7,29
88.03.630	18 x 2 - 1/2" *	10	100	7,29
88.03.635	20 x 2 - 1/2" *	10	100	7,29

• KIT 3/4 EUROKONO

SONDERABMESSUNGEN - SPECIAL SIZES - MISURE SPECIALI

KLEMMANSCHLUSSVERSCHRAUBUNG MIT IG
FEMALE STRAIGHT COUPLING





ART. NUMMER ARTICLE NUMBER	ABMESSUNG SIZE			EURO	
88.03.710	16 x 2 - 1/2"	10	120	5,38	
88.03.711	16 x 2,25 - 1/2"	10	100	5,66	
88.03.714	14 x 2 - 1/2"	*	100	7,06	
88.03.715	16 x 2 - 1/2"	*	100	7,06	
88.03.716	16 x 2,25 - 1/2"	*	100	7,06	
88.03.720	17 x 2 - 1/2"	*	100	7,28	
88.03.725	18 x 2 - 1/2"	*	100	7,28	
88.03.730	20 x 2 - 1/2"	*	100	7,28	
88.03.731	20 x 2,5 - 1/2"	*	100	7,28	
88.03.735	16 x 2 - 3/4"	*	80	7,82	
88.03.736	16 x 2,25 - 3/4"	*	80	7,82	
88.03.740	17 x 2 - 3/4"	*	80	7,82	
88.03.745	18 x 2 - 3/4"	*	80	7,82	
88.03.750	20 x 2 - 3/4"	*	5	80	7,82
88.03.751	20 x 2,5 - 3/4"	*	5	80	7,82
88.03.755	26 x 3 - 3/4"	*	5	50	10,35
88.03.775	26 x 3 - 1"	*	5	50	12,25
88.03.780	32 x 3 - 1"	*	5	40	25,00

• KIT 3/4 EUROKONO

PRÜFUNG-STOPFEN
PRESSURE TEST PLUGS





ART. NUMMER ARTICLE NUMBER	ABMESSUNG SIZE			EURO
87.31.605	16 x 2	10	100	7,66
87.31.610	18 x 2	10	100	12,00
87.31.615	20 x 2	10	100	12,00
87.31.620	26 x 3	5	50	24,05

**PRÜFUNG-STOPFEN
PRESSURE TEST PLUGS**

KLEMM-WINKEL 90°
ELBOW 90°





ART. NUMMER ARTICLE NUMBER	ABMESSUNG SIZE			EURO	
88.04.015	16 x 2	10	100	7,92	
88.04.016	16 x 2,25	10	100	8,32	
88.04.019	14 x 2	*	70	10,24	
88.04.020	16 x 2	*	70	11,45	
88.04.021	16 x 2,25	*	70	11,45	
88.04.025	17 x 2	*	70	11,45	
88.04.030	18 x 2	*	70	11,45	
88.04.035	20 x 2	*	70	11,45	
88.04.036	20 x 2,5	*	5	70	11,45
88.04.045	26 x 3	5	30	18,35	
88.04.050	32 x 3	5	20	43,35	

• KIT 3/4 EUROKONO

KLEMM-WINKEL MIT AG 90°
MALE ELBOW 90°



ART. NUMMER ARTICLE NUMBER	ABMESSUNG SIZE			EURO	
88.04.115	16 x 2 - 1/2"	10	100	5,82	
88.04.116	16 x 2,25 - 1/2"	10	100	6,13	
88.04.119	14 x 2 - 1/2"	*	60	7,58	
88.04.120	16 x 2 - 1/2"	*	60	8,10	
88.04.121	16 x 2,25 - 1/2"	*	60	8,10	
88.04.125	17 x 2 - 1/2"	*	60	8,10	
88.04.130	18 x 2 - 1/2"	*	60	8,10	
88.04.135	20 x 2 - 1/2"	*	60	8,10	
88.04.136	20 x 2,5 - 1/2"	*	60	8,10	
88.04.140	16 x 2 - 3/4"	*	60	8,10	
88.04.141	16 x 2,25 - 3/4"	*	60	8,10	
88.04.145	17 x 2 - 3/4"	*	60	8,10	
88.04.150	18 x 2 - 3/4"	*	60	8,10	
88.04.155	20 x 2 - 3/4"	*	5	60	8,10
88.04.156	20 x 2,5 - 3/4"	*	5	60	8,10
88.04.160	26 x 3 - 3/4"	5	30	12,25	
88.04.180	26 x 3 - 1"	5	30	13,50	
88.04.185	32 x 3 - 1"	5	20	30,24	

• KIT 3/4 EUROKONO

SONDERABMESSUNGEN - SPECIAL SIZES - MISURE SPECIALI



KLEMM-WINKEL MIT IG 90°
 FEMALE ELBOW 90°



ART. NUMBER ARTICLE NUMBER	ABMESSUNG SIZE			EURO	
88.04.215	16 x 2 - 1/2"	10	100	6,12	
88.04.216	16 x 2,25 - 1/2"	10	100	6,43	
88.04.219	14 x 2 - 1/2"	*	10	60	8,34
88.04.220	16 x 2 - 1/2"	*	10	60	8,34
88.04.221	16 x 2,25 - 1/2"	*	10	60	8,34
88.04.225	17 x 2 - 1/2"	*	10	60	8,62
88.04.230	18 x 2 - 1/2"	*	10	60	8,62
88.04.235	20 x 2 - 1/2"	*	10	60	8,62
88.04.236	20 x 2,5 - 1/2"	*	10	60	8,62
88.04.239	14 x 2 - 3/4"	*	10	60	9,13
88.04.240	16 x 2 - 3/4"	*	10	60	9,13
88.04.241	16 x 2,25 - 3/4"	*	10	60	9,13
88.04.245	17 x 2 - 3/4"	*	10	60	9,13
88.04.250	18 x 2 - 3/4"	*	10	60	9,13
88.04.255	20 x 2 - 3/4"	*	10	60	9,13
88.04.256	20 x 2,5 - 3/4"	*	5	60	9,13
88.04.260	26 x 3 - 3/4"		5	30	15,65
88.04.280	26 x 3 - 1"		5	30	14,35
88.04.285	32 x 3 - 1"		5	20	32,10

• KIT 3/4 EUROKONO

KLEMM-WANDWINKEL 90°
 ELBOW WITH WALLPLATE 90°



ART. NUMBER ARTICLE NUMBER	ABMESSUNG SIZE			EURO	
88.04.315	16 x 2 - 1/2"	10	80	7,09	
88.04.316	16 x 2,25 - 1/2"	10	80	7,96	
88.04.319	14 x 2 - 1/2"	*	10	60	8,12
88.04.320	16 x 2 - 1/2"	*	10	60	9,13
88.04.321	16 x 2,25 - 1/2"	*	10	60	9,13
88.04.325	17 x 2 - 1/2"	*	10	60	9,13
88.04.330	18 x 2 - 1/2"	*	10	60	9,13
88.04.335	20 x 2 - 1/2"	*	10	60	9,13
88.04.336	20 x 2,5 - 1/2"	*	10	60	9,13
88.04.350	16 x 2 - 3/4"	*	10	60	10,15
88.04.351	16 x 2,25 - 3/4"	*	10	60	10,15
88.04.355	17 x 2 - 3/4"	*	10	60	10,15
88.04.360	18 x 2 - 3/4"	*	10	60	10,15
88.04.365	20 x 2 - 3/4"	*	5	60	10,15

3 FACH BOHRUNG • 3 FIXING HOLES

• KIT 3/4 EUROKONO

T- STÜCK
 TEE

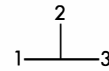

ART. NUMBER ARTICLE NUMBER	ABMESSUNG SIZE			EURO	
88.04.515	16 x 16 x 16	5	100	10,40	
88.04.516	16 x 2,25 - 16 x 2,25 - 16 x 2,25	5	60	12,08	
88.04.519	14 x 14x14	*	5	40	15,13
88.04.520	16 x 16x16	*	5	40	16,95
88.04.525	17 x 17x17	*	5	40	16,95
88.04.530	18 x 18x18	*	5	40	16,95
88.04.535	20 x 20x20	*	5	40	16,95
88.04.536	20 x 2,5 - 20 x 2,5 - 20 x 2,5	*	5	40	16,95
88.04.540	26 x 26x26		5	20	26,10
88.04.532	32 x 32x32		5	30	52,13

• KIT 3/4 EUROKONO

T- STÜCK REDUZIERT
 REDUCING TEE

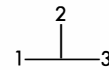



ART. NUMBER ARTICLE NUMBER	ABMESSUNG SIZE			EURO	
88.04.541	16 x 2 - 18 x 2 - 16 x 2	*	5	40	16,67
88.04.444	16 x 2 - 20 x 2 - 16 x 2	*	5	40	18,55
88.04.542	18 x 2 - 16 x 2 - 16 x 2	*	5	40	16,65
88.04.543	18 x 2 - 18 x 2 - 16 x 2	*	5	40	16,65
88.04.544	18 x 2 - 18 x 2 - 20 x 2	*	5	40	16,65
88.04.545	18 x 2 - 20 x 2 - 16 x 2	*	5	40	16,65
88.04.546	18 x 2 - 20 x 2 - 18 x 2	*	5	40	16,65
88.04.547	20 x 2 - 18 x 2 - 16 x 2	*	5	40	16,65
88.04.548	20 x 2 - 18 x 2 - 18 x 2	*	5	40	16,65
88.04.549	20 x 2 - 20 x 2 - 18 x 2	*	5	40	16,65
88.04.550	20 x 2 - 16 x 2 - 18 x 2	*	5	40	16,65
88.04.555	18 x 2 - 16 x 2 - 18 x 2	*	5	40	16,65
88.04.558	20 x 2 - 16 x 2 - 16 x 2	*	5	40	16,65
88.04.560	20 x 2 - 16 x 2 - 20 x 2	*	5	40	16,65
88.04.565	20 x 2 - 18 x 2 - 20 x 2	*	5	40	16,65
88.04.566	20 x 2 - 20 x 2 - 16 x 2	*	5	40	16,65
88.04.580	26 x 3 - 16 x 2 - 26 x 3		5	40	25,02
88.04.590	26 x 3 - 20 x 2 - 26 x 3		5	40	25,02

• KIT 3/4 EUROKONO



SONDERABMESSUNGEN - SPECIAL SIZES



ART. NUMMER ARTICLE NUMBER	ABMESSUNG SIZE			EURO
88.04.615	16 x 1/2" x 16	5	60	9,38
88.04.616	16 x 2,25 - 1/2" - 16 x 2,25	5	60	10,95
88.04.619	14 x 1/2" x 14	*	5 40	12,75
88.04.620	16 x 1/2" x 16	*	5 40	12,75
88.04.621	16 x 2,25 - 1/2" - 16 x 2,25	*	5 40	12,75
88.04.625	17 x 1/2" x 17	*	5 40	12,75
88.04.630	18 x 1/2" x 18	*	5 40	12,75
88.04.635	20 x 1/2" x 20	*	5 40	12,75
88.04.636	20 x 2,5 - 1/2" - 20 x 2,5	*	5 40	12,75
88.04.640	16 x 3/4" x 16	*	5 40	13,00
88.04.641	16 x 2,25 - 3/4" - 16 x 2,25	*	5 40	13,00
88.04.645	17 x 3/4" x 17	*	5 40	13,00
88.04.650	18 x 3/4" x 18	*	5 40	13,00
88.04.655	20 x 3/4" x 20	*	5 40	13,00
88.04.656	20 x 2,5 - 3/4" - 20 x 2,5	*	5 40	13,00
88.04.660	26 x 3/4" x 26	5	20	26,85
88.04.680	26 x 1" x 26	5	20	26,85
88.04.685	32 x 1" x 32	5	20	50,00

• KIT 3/4 EUROKONO



ART. NUMMER ARTICLE NUMBER	ABMESSUNG SIZE			EURO
88.04.715	16 x 1/2" x 16		60	9,58
88.04.716	16 x 2,25 - 1/2" - 16 x 2,25	5	60	10,07
88.04.719	14 x 3/4" x 14	*	5 40	13,03
88.04.720	16 x 3/4" x 16	*	5 40	13,30
88.04.721	16 x 2,25 - 3/4" - 16 x 2,25	*	5 40	13,30
88.04.725	17 x 3/4" x 17	*	5 40	13,30
88.04.730	18 x 3/4" x 18	*	5 40	13,30
88.04.735	20 x 3/4" x 20	*	5 40	13,30
88.04.736	20 x 2,5 - 3/4" - 20 x 2,5	*	5 40	13,30
88.04.740	26 x 3/4" x 26	5	10	26,85
88.04.760	26 x 1" x 26	5	10	26,85
88.04.765	32 x 1" x 32	5	10	45,25

• KIT 3/4 EUROKONO

SONDERABMESSUNGEN - SPECIAL SIZES



ANSCHLUSSDOSE - 105°
 3/4" EURO x 1/2" IG

BUILT-IN DISTRIBUTION BOX
 WITH 105° FITTING
 3/4" EURO x 1/2" F



ART. NUMMER ARTICLE NUMBER	ABMESSUNG SIZE	EURO
88.03.205	3/4" Euro x 1/2" F	16,90

ANSCHLUSSDOSE - 105°
 3/4" EURO x 1/2" IG

BUILT-IN DISTRIBUTION BOX
 WITH 105° FITTING
 3/4" EURO x 1/2" F



ART. NUMMER ARTICLE NUMBER	ABMESSUNG SIZE	EURO
88.03.206	3/4" Euro x 1/2" F	18,55

BESTANDTEILE DER WANDDOSSE
 BOX COMPONENTS



BESTANDTEILE DER WANDDOSSE
 BOX COMPONENTS



PEX-ROHR - PEX PIPE - TUBO PEX

DOPPELDOSE
 3/4" EURO x 3/4" EURO x 1/2" IG

DOUBLE-EXIT UNDERCARPET
 DISTRIBUTION BOX
 FOR SERIAL CONNECTIONS
 3/4" EURO x 3/4" EURO x 1/2" F



ANSCHLUSSDOSE - 105°
 1/2" IG
 16 x 2 PEX

BUILT-IN DISTRIBUTION BOX
 WITH 105° FITTING
 1/2" F - 16 x 2 PEX



ART. NUMMER ARTICLE NUMBER	ABMESSUNG SIZE	EURO
88.03.210	3/4" Euro x 3/4" Euro x 1/2" F	42,93

ART. NUMMER ARTICLE NUMBER	ABMESSUNG SIZE	EURO
88.03.220	1/2" F - 16 x 2 PEX	17,10

BESTANDTEILE DER WANDDOSSE
 BOX COMPONENTS



BESTANDTEILE DER WANDDOSSE
 BOX COMPONENTS

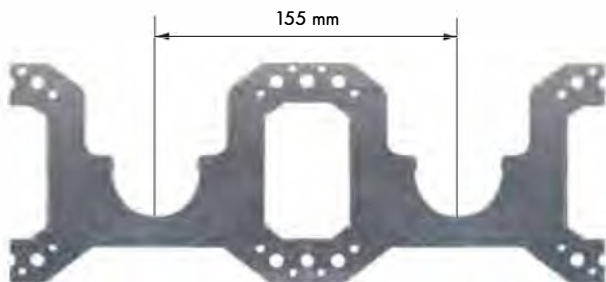

MONTAGE-SCHABLONE FÜR ANSCHLUSSDOSE
 TEMPLATE FOR UNDERCARPET DISTRIBUTION BOX

ART. NUMMER ARTICLE NUMBER	ABMESSUNG SIZE	EURO
88.03.200	155	6,88

COMISA



QUALITÄT eine ENTSCHEIDUNG FÜRS LEBEN • **QUALITY** a CHOICE OF LIFE



15/10/2022



25055 PISOONE (BS) - Italy - Località Neziole - Zona Artigianale, 27
Tel. + 39 0364.896811 - Fax +39 0364.896825 - www.comisa.it



QUALITÄT eine ENTSCHEIDUNG FÜRS LEBEN
QUALITY a CHOICE OF LIFE

